

MORLEY MK-3

1/7 NEAR SCALE HUGHES 300

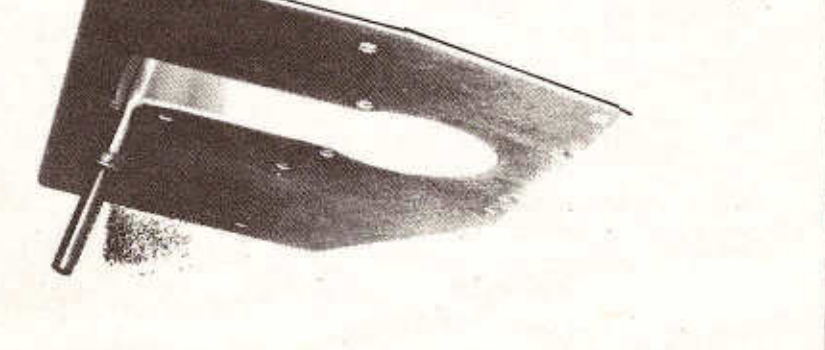
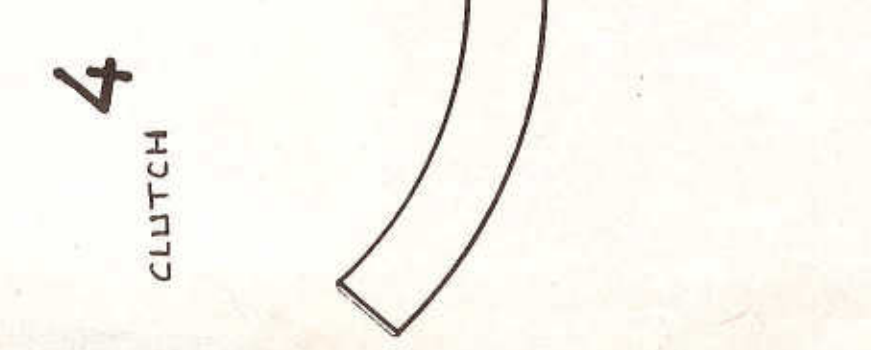
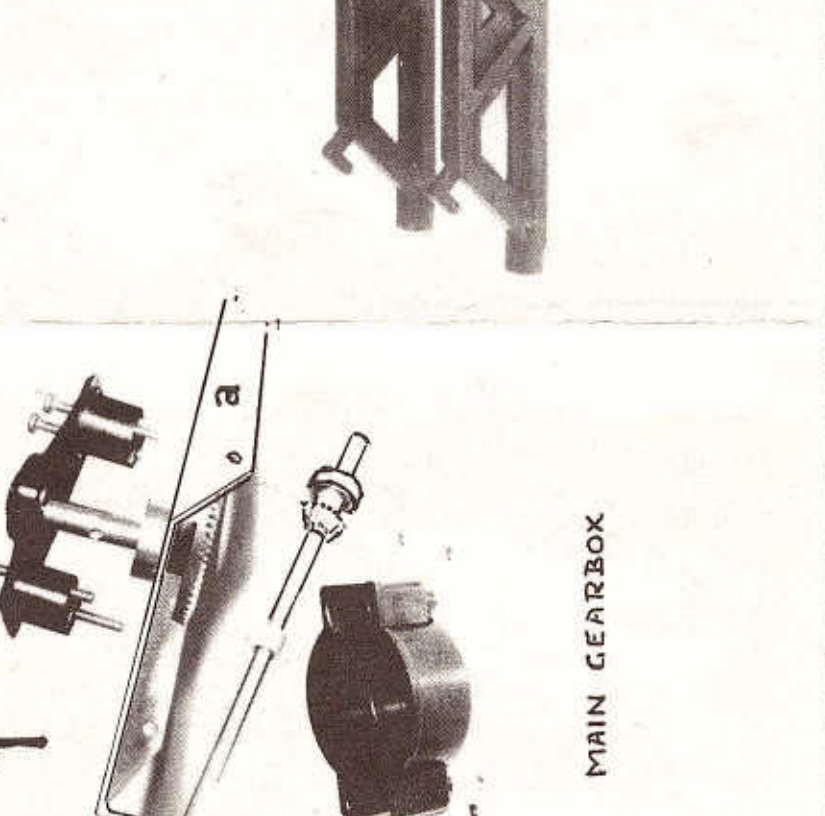
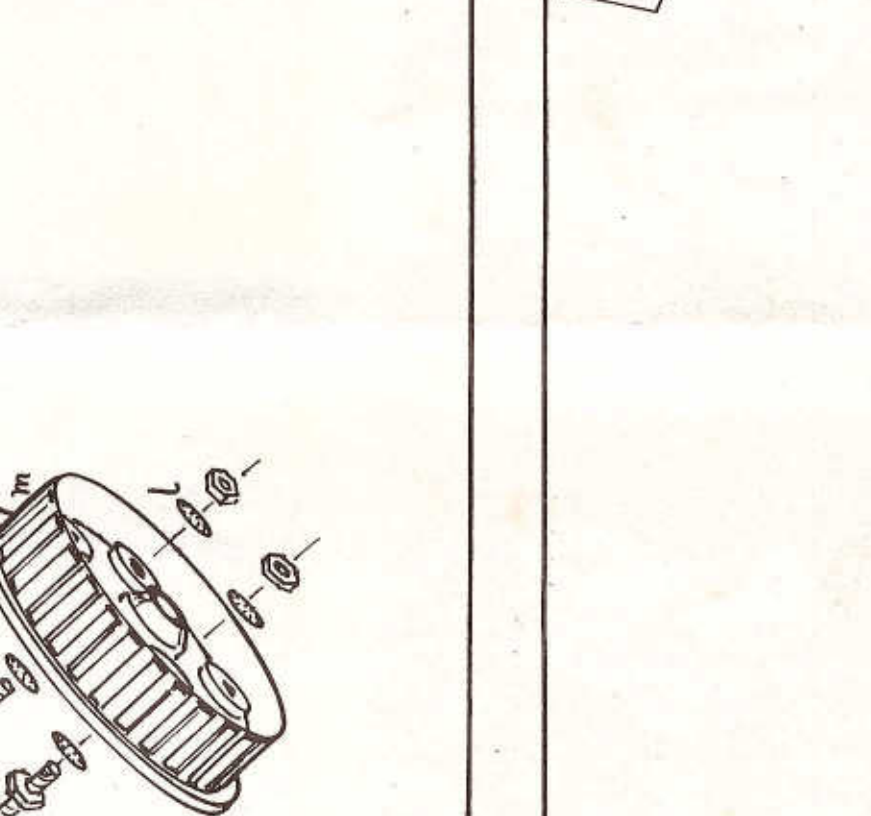
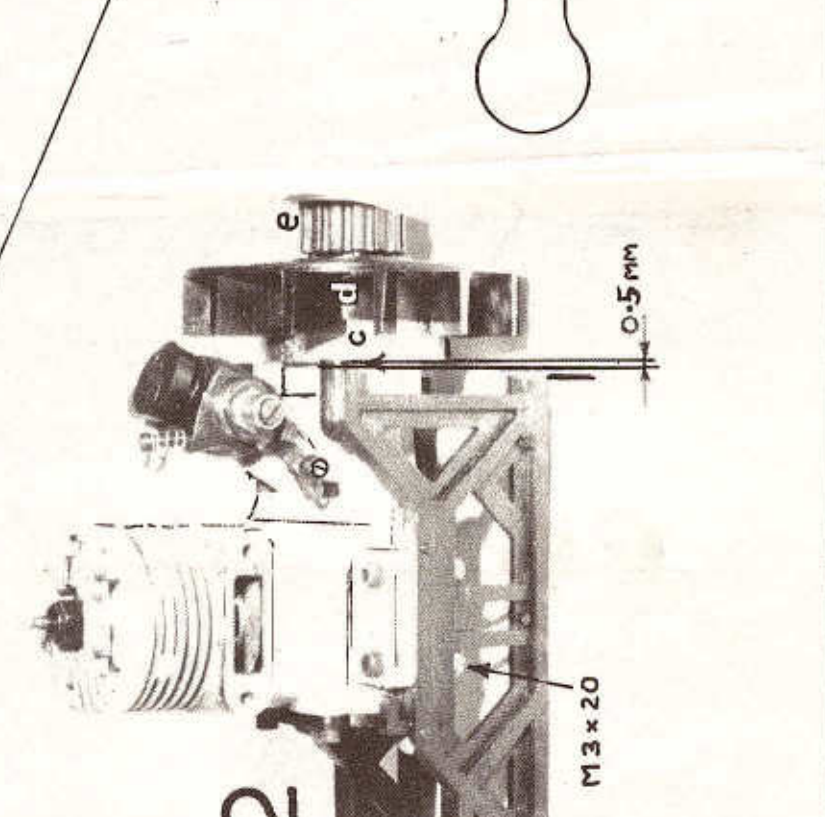
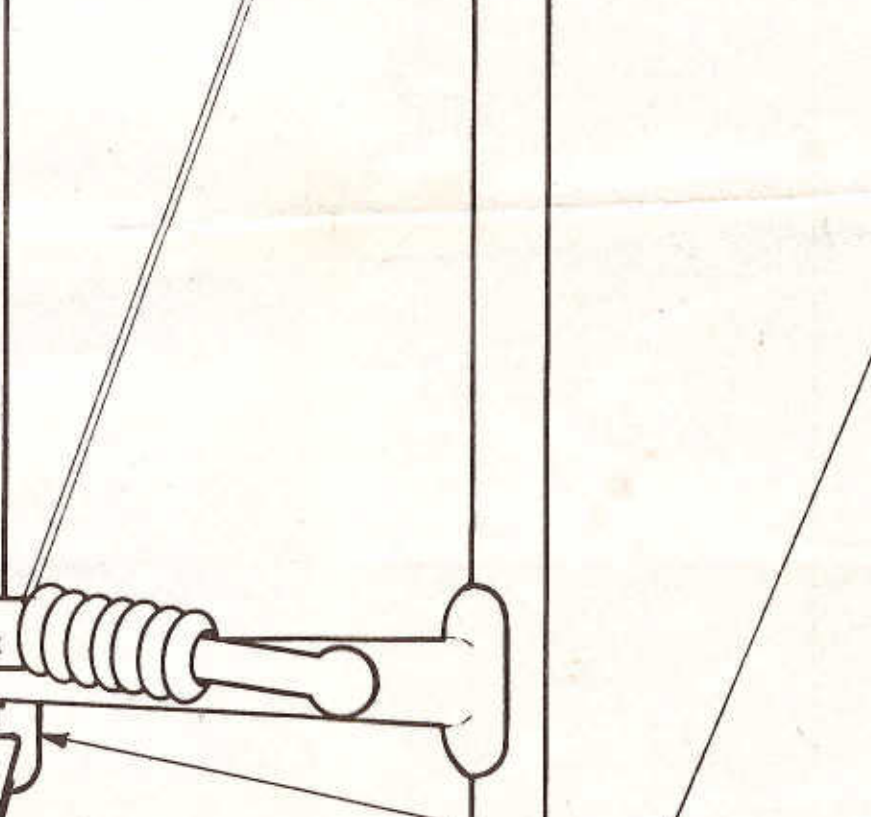
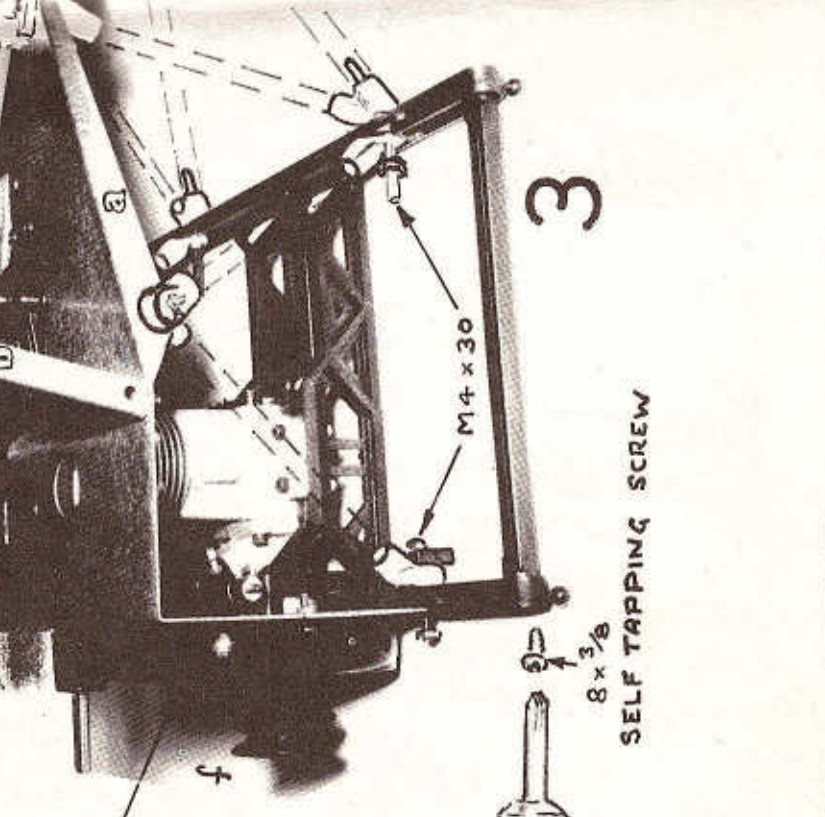
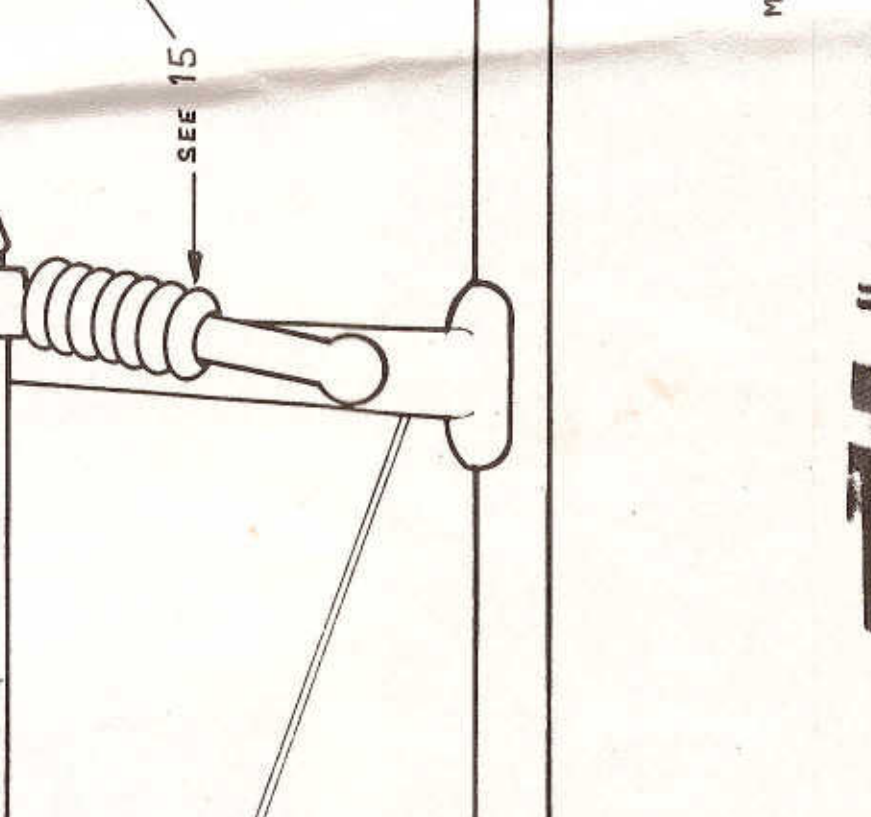
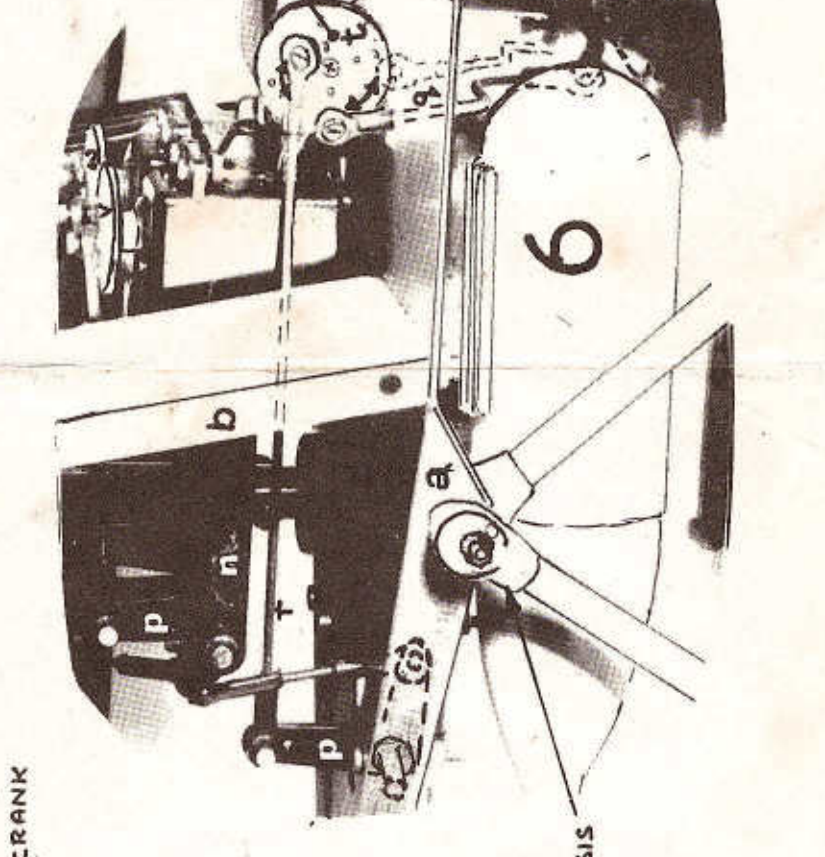
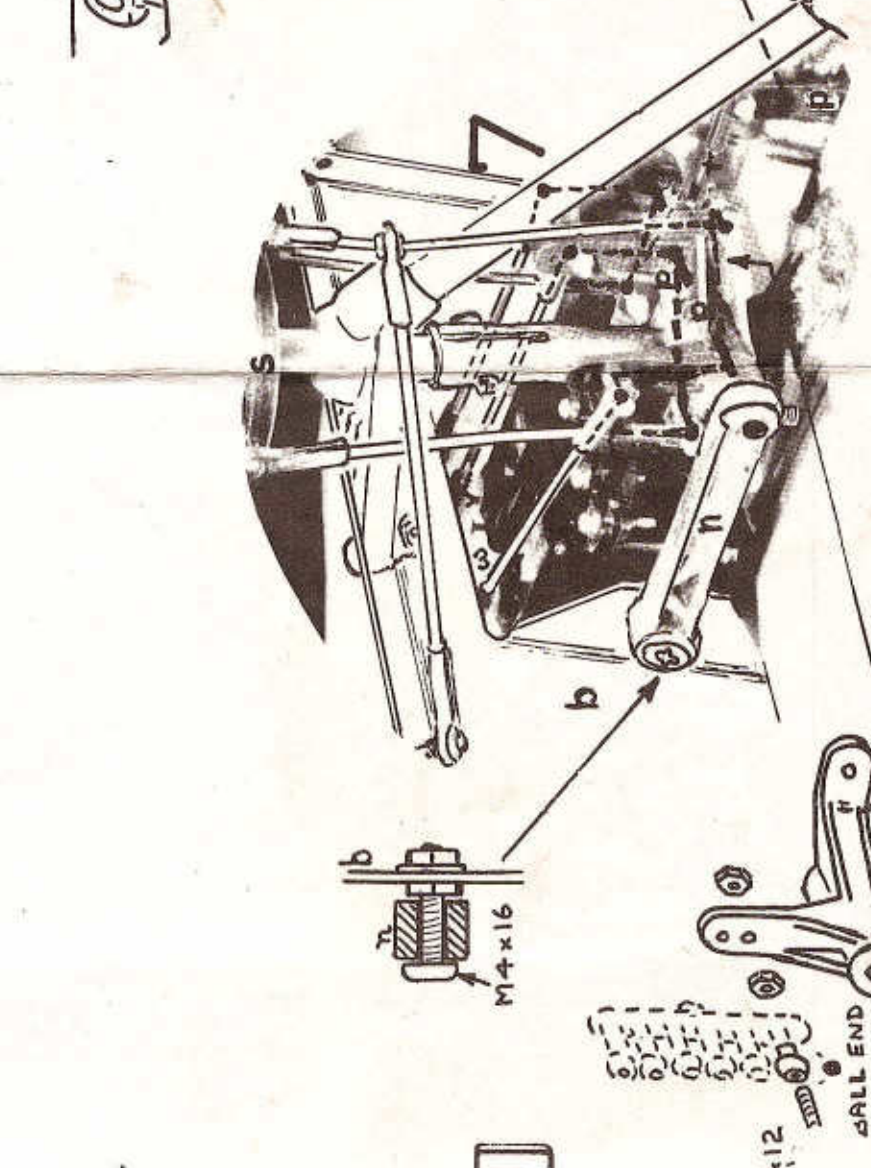
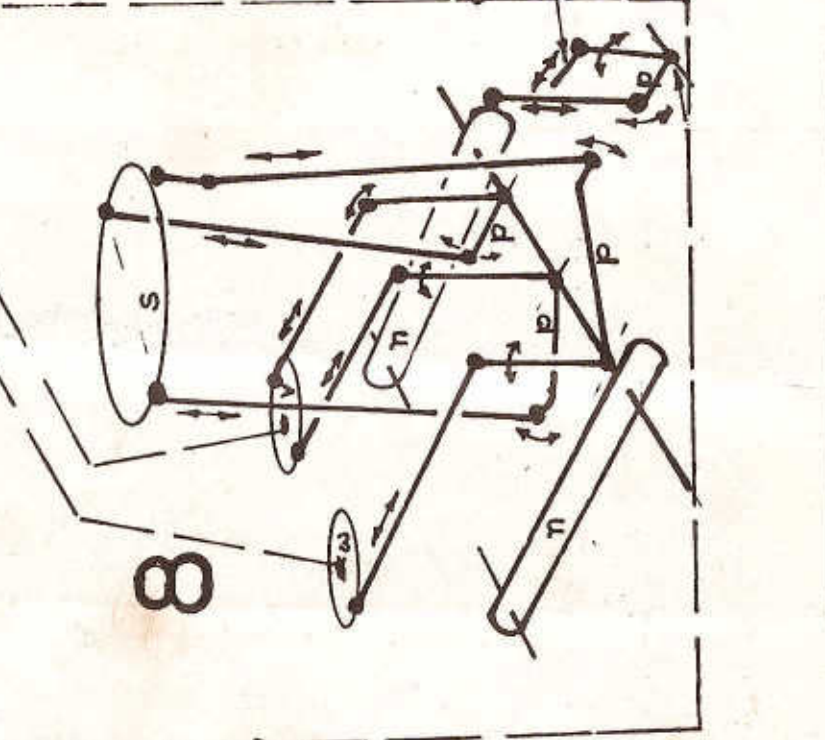
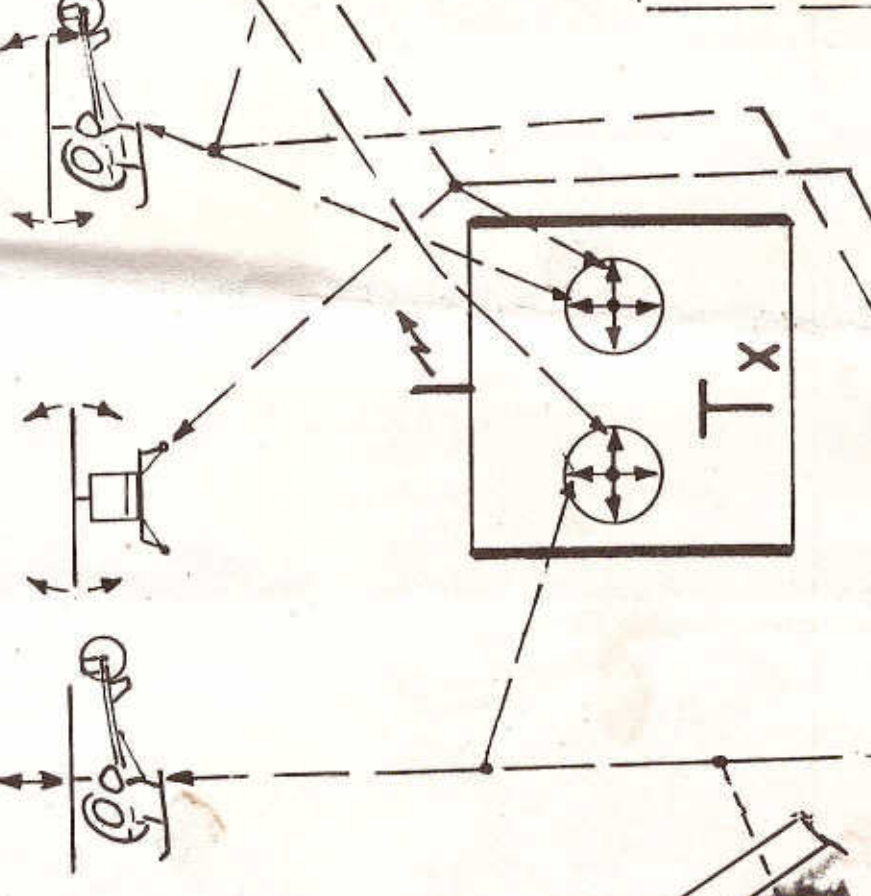
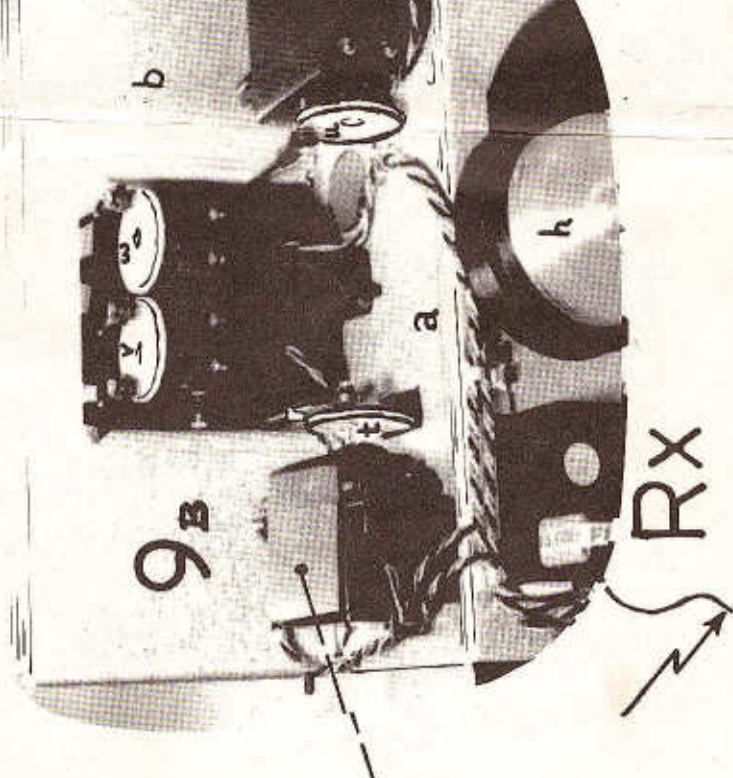
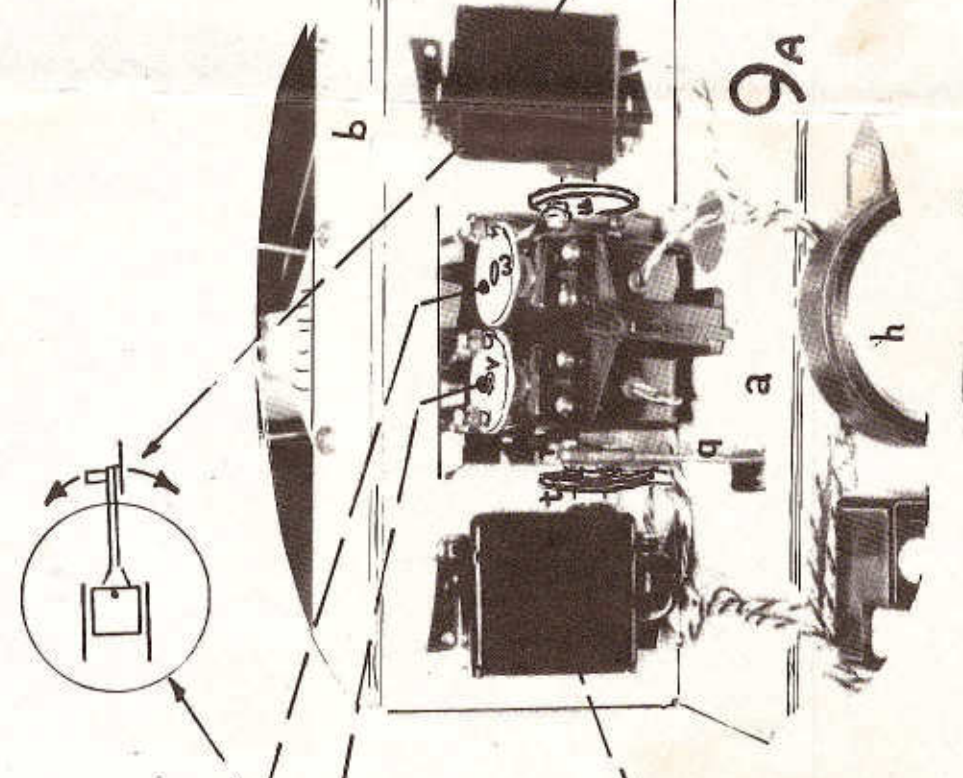
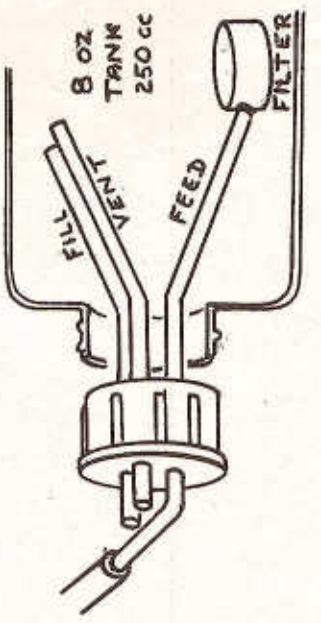
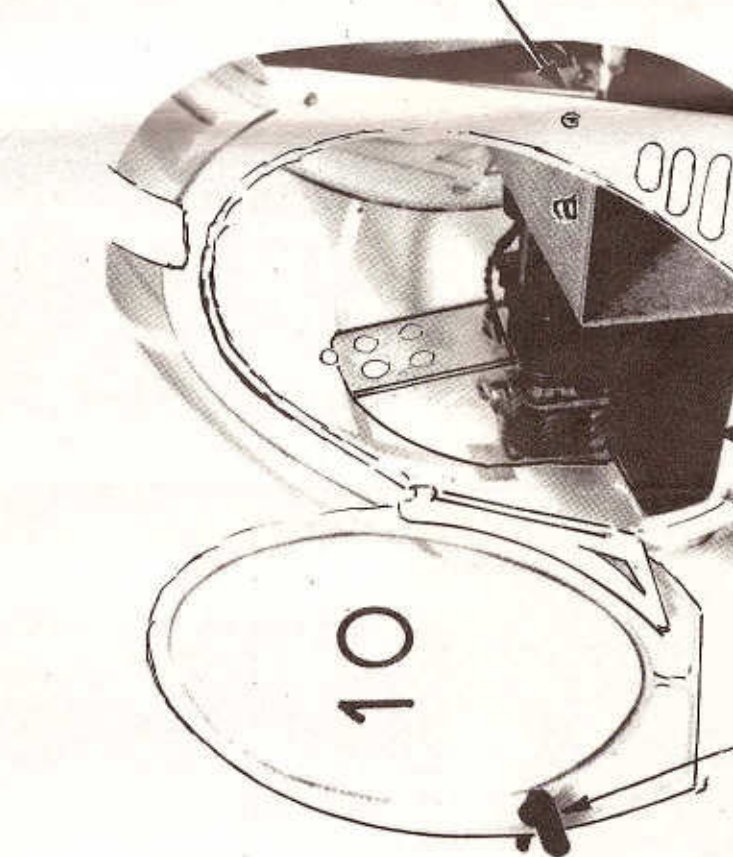
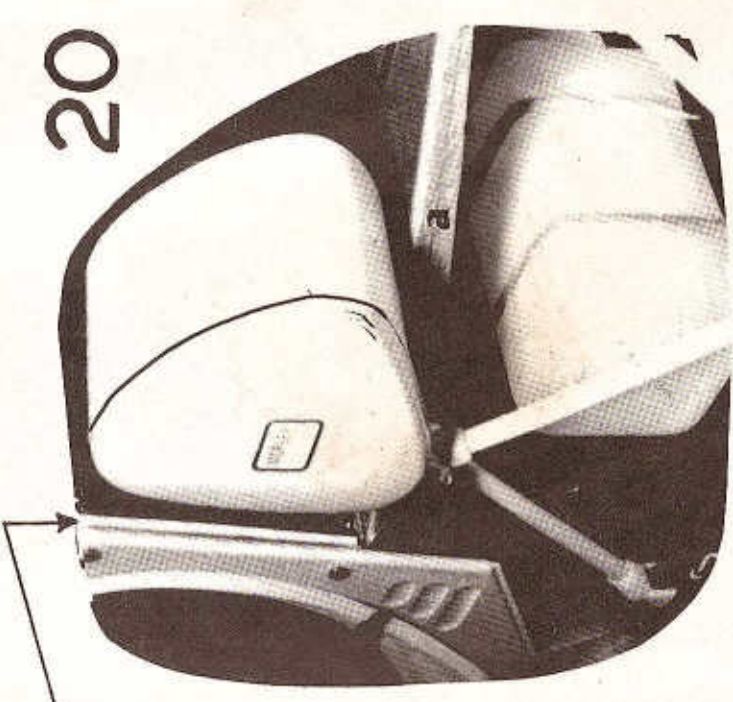
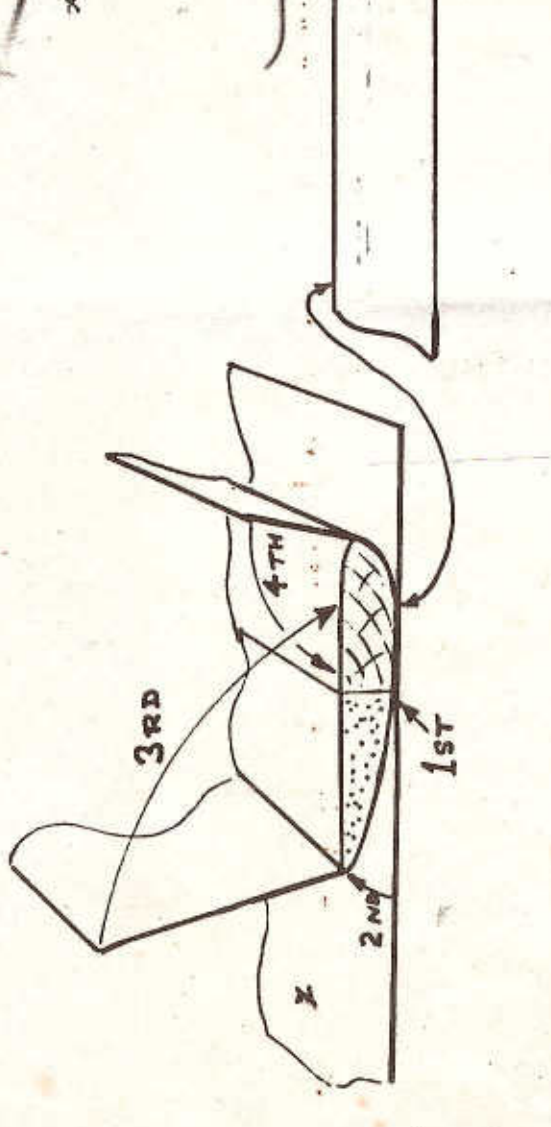
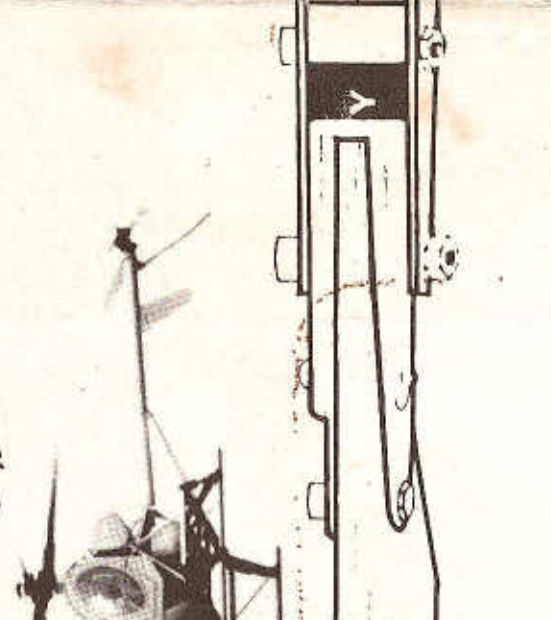
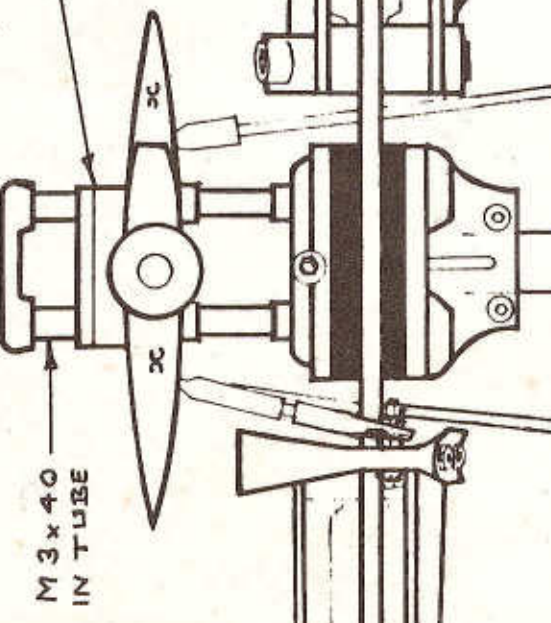
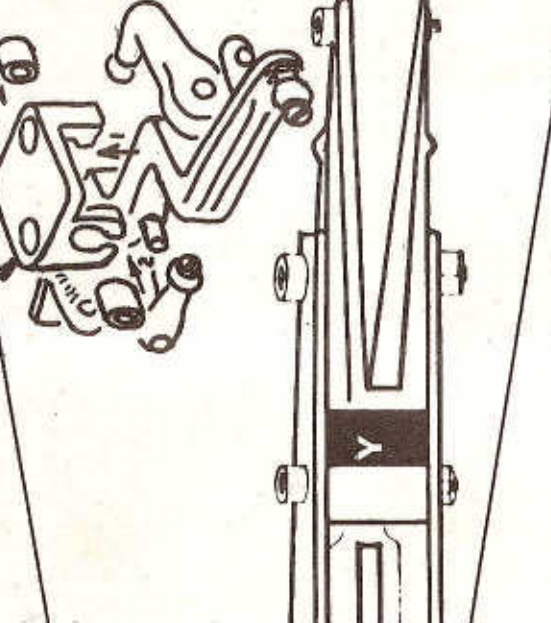
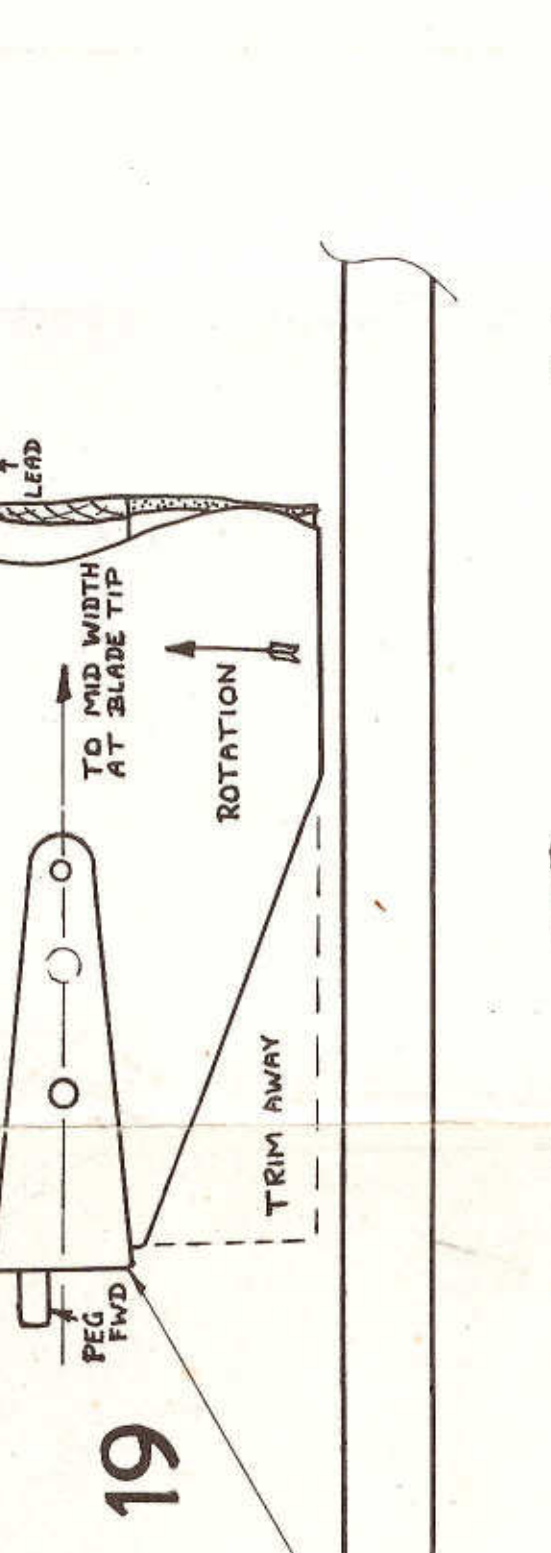
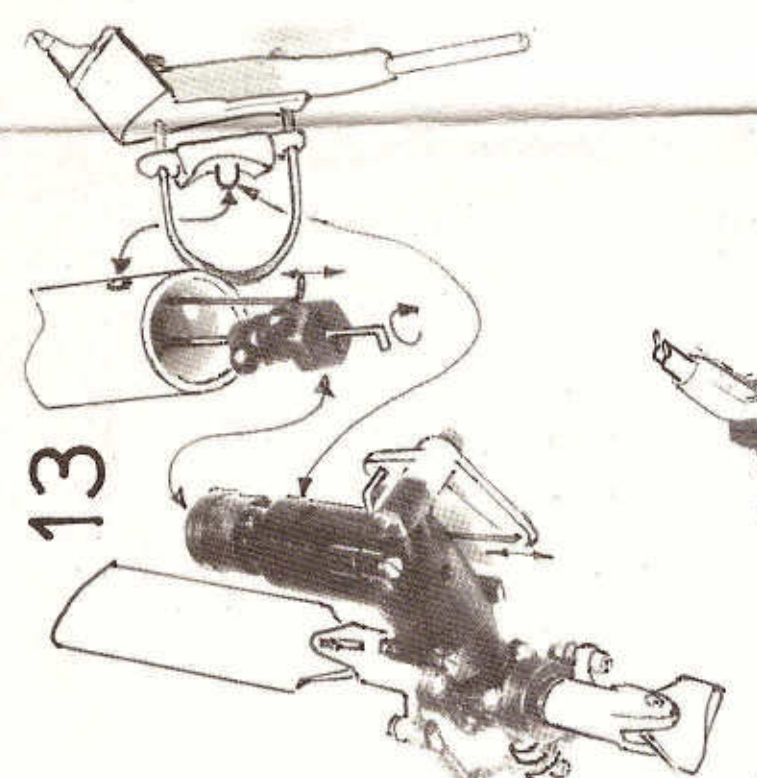
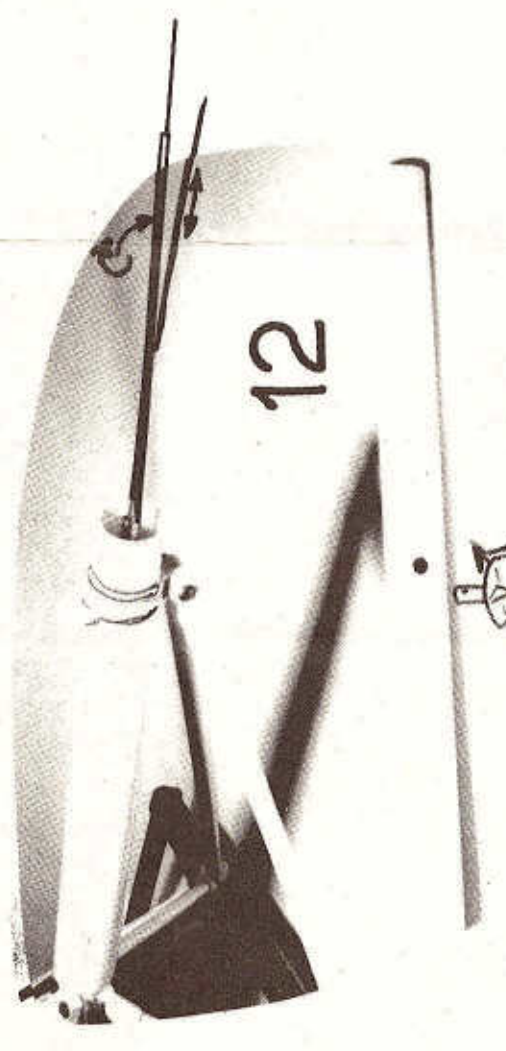
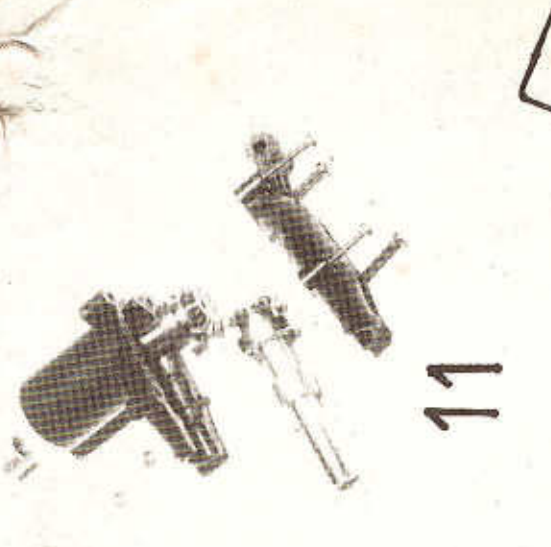
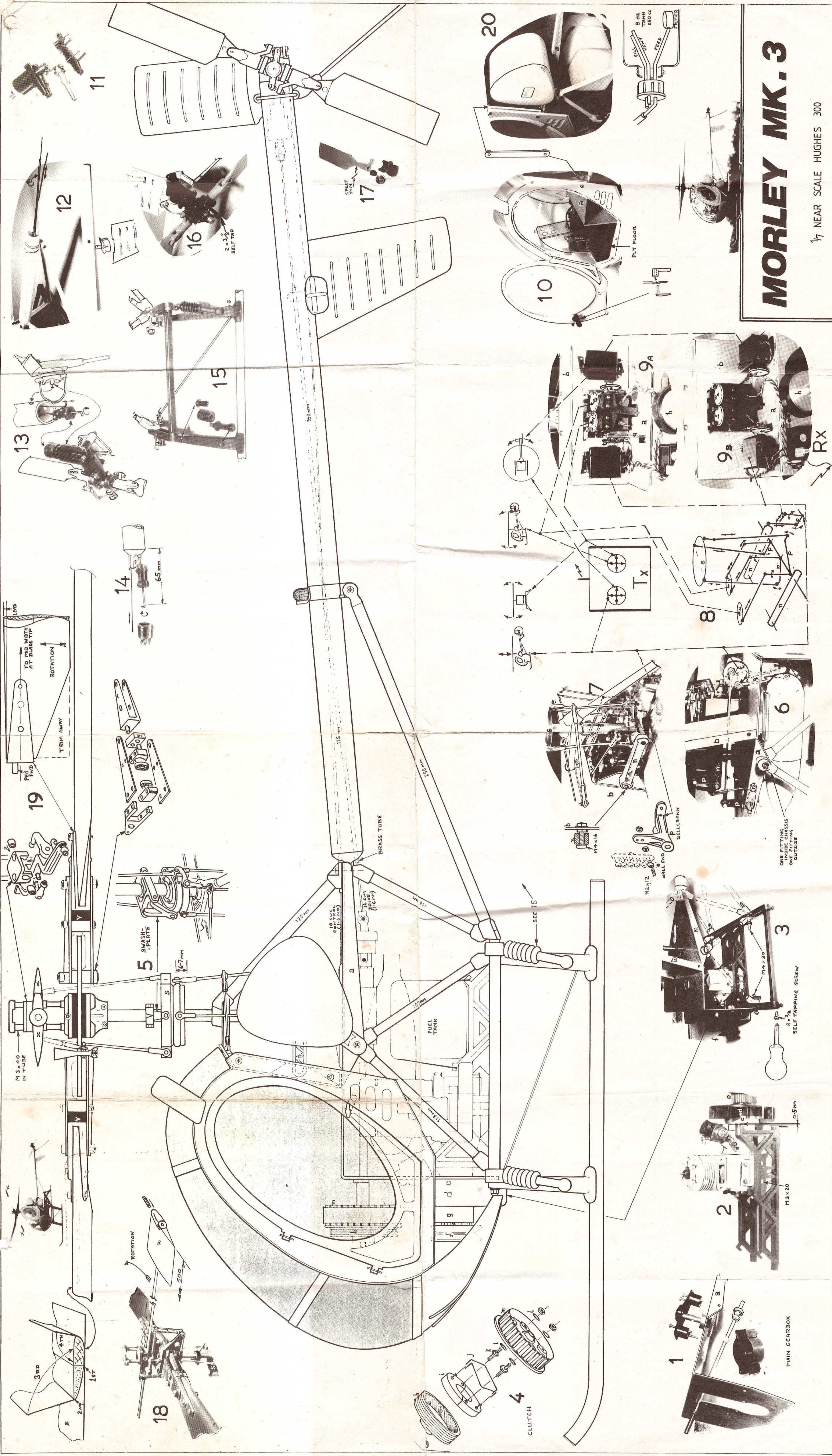

RX

ONE FITTING INSIDE CHASSIS ONE FITTING OUTSIDE

SELF TAPPING SCREW
0.5 mm

MAIN GEARBOX

CLUTCH